

Dreux 4x3

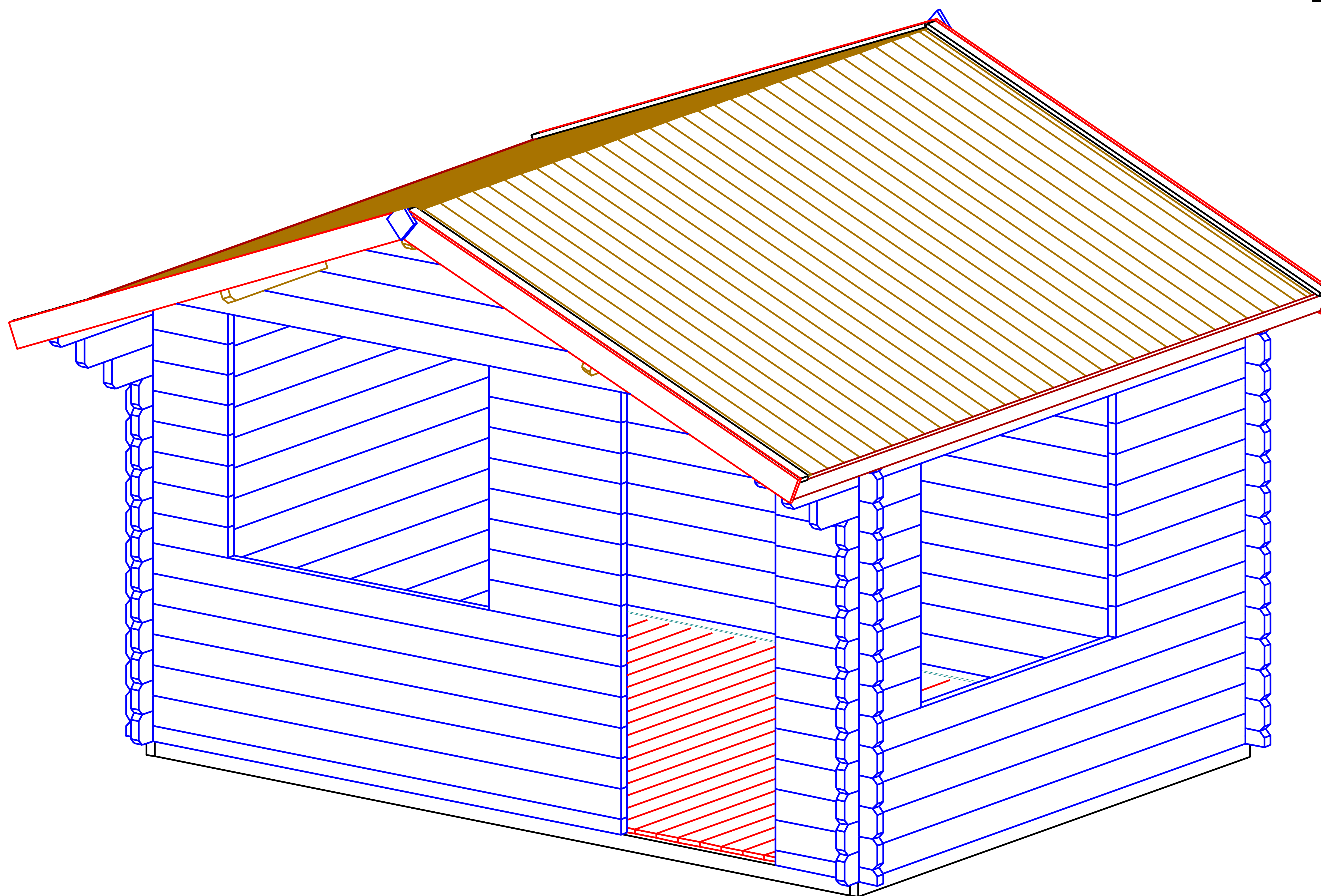

Dreux 4x3

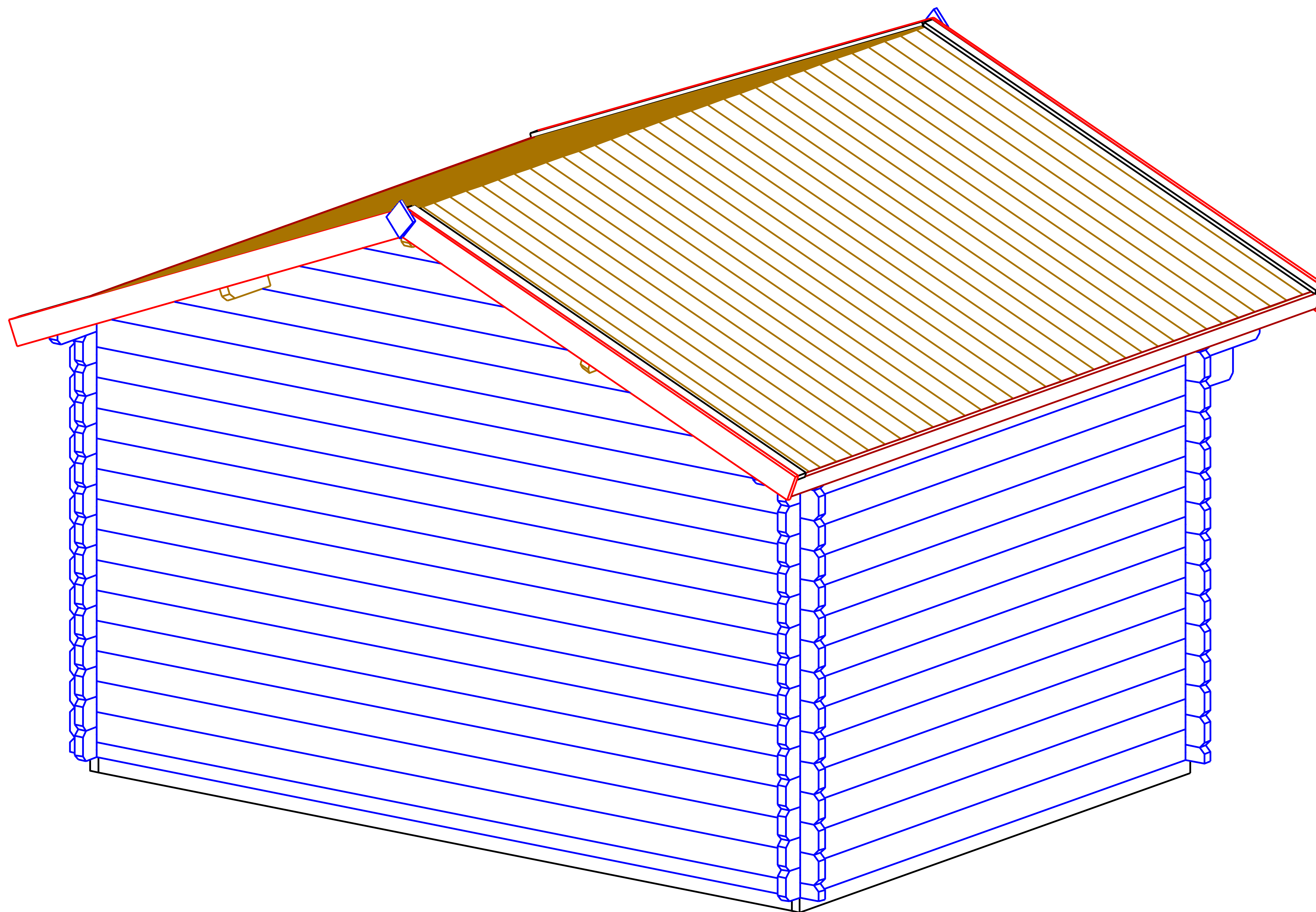

Dreux 4x3

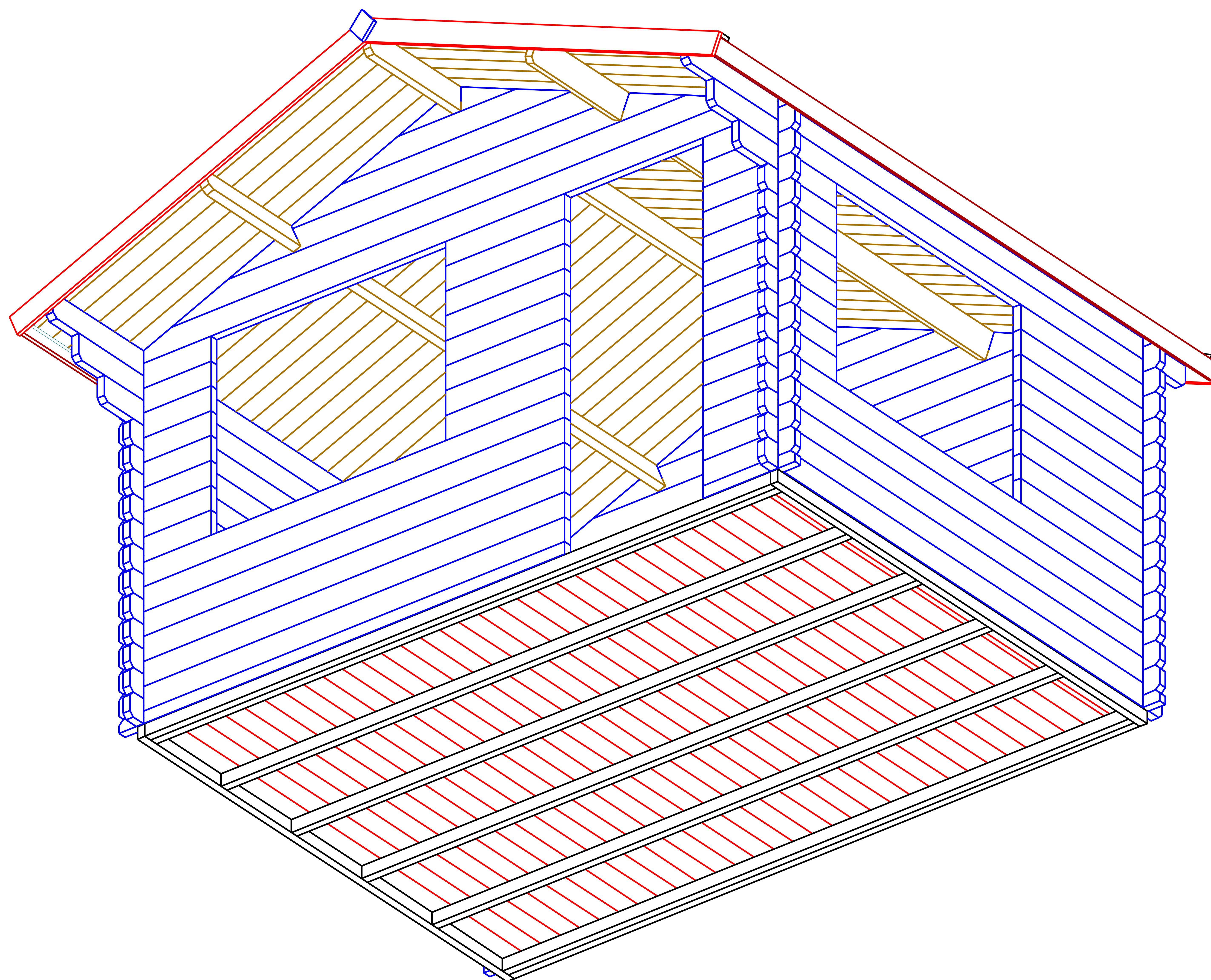

Dreux 4x3

Plan

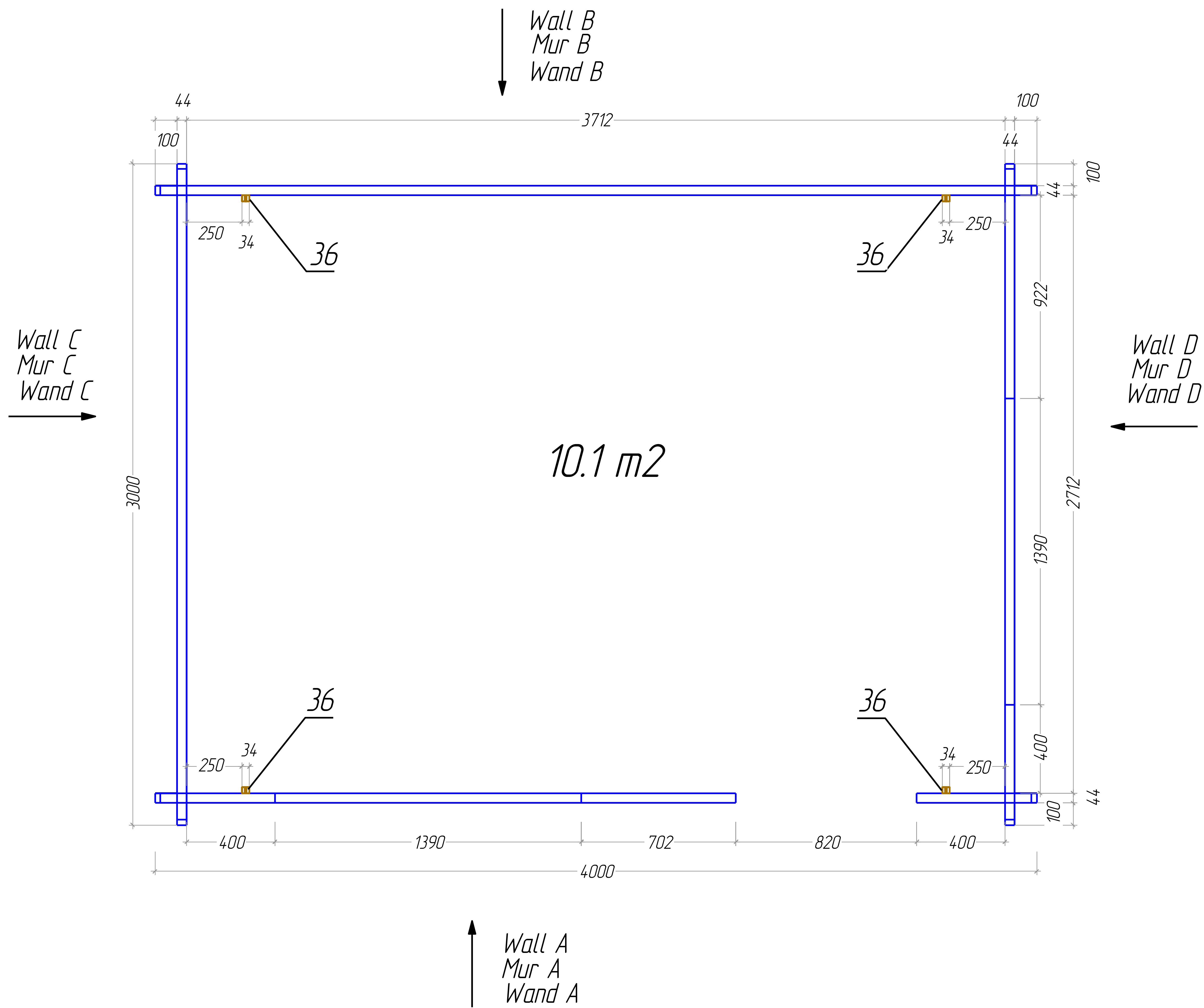

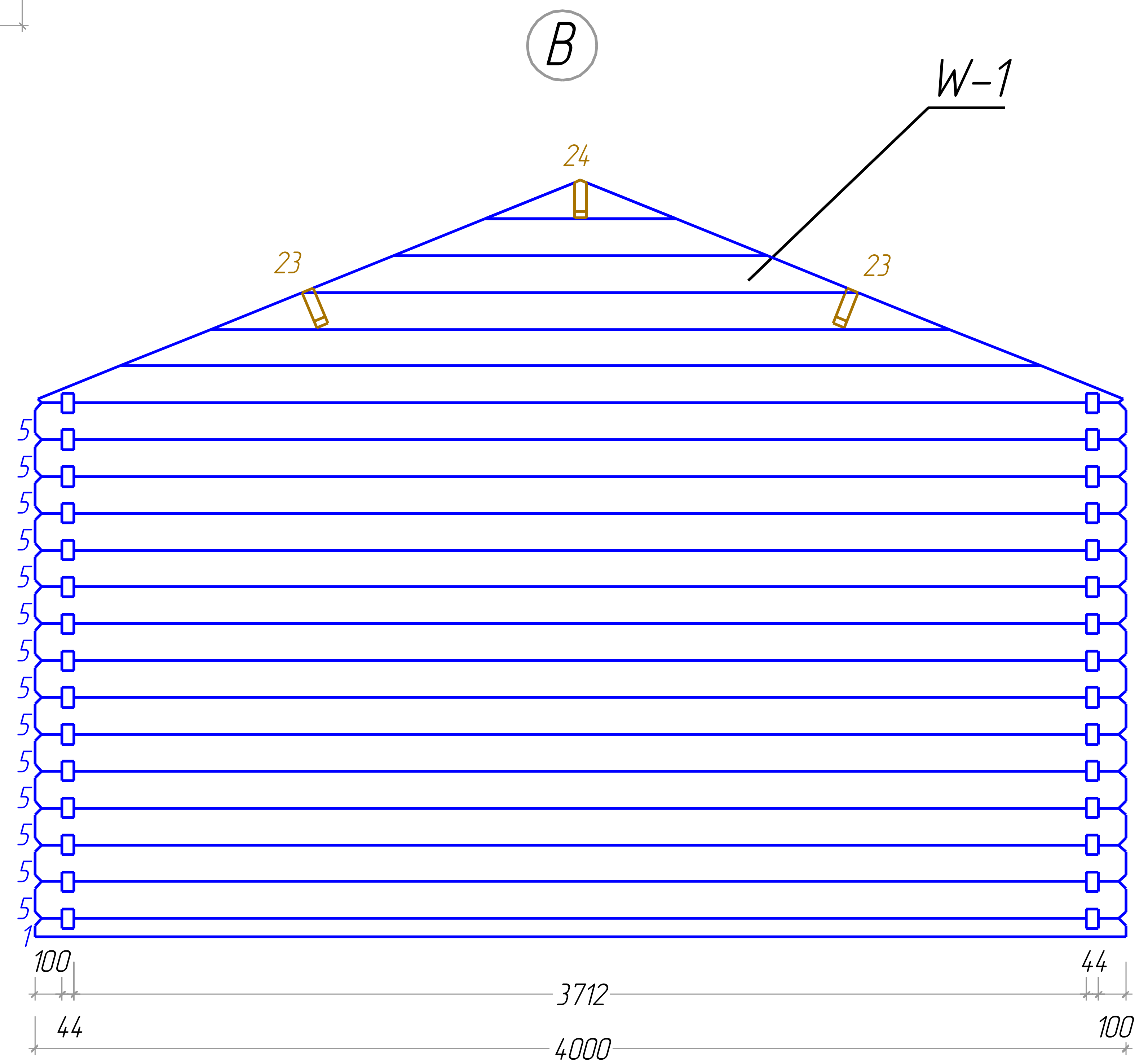
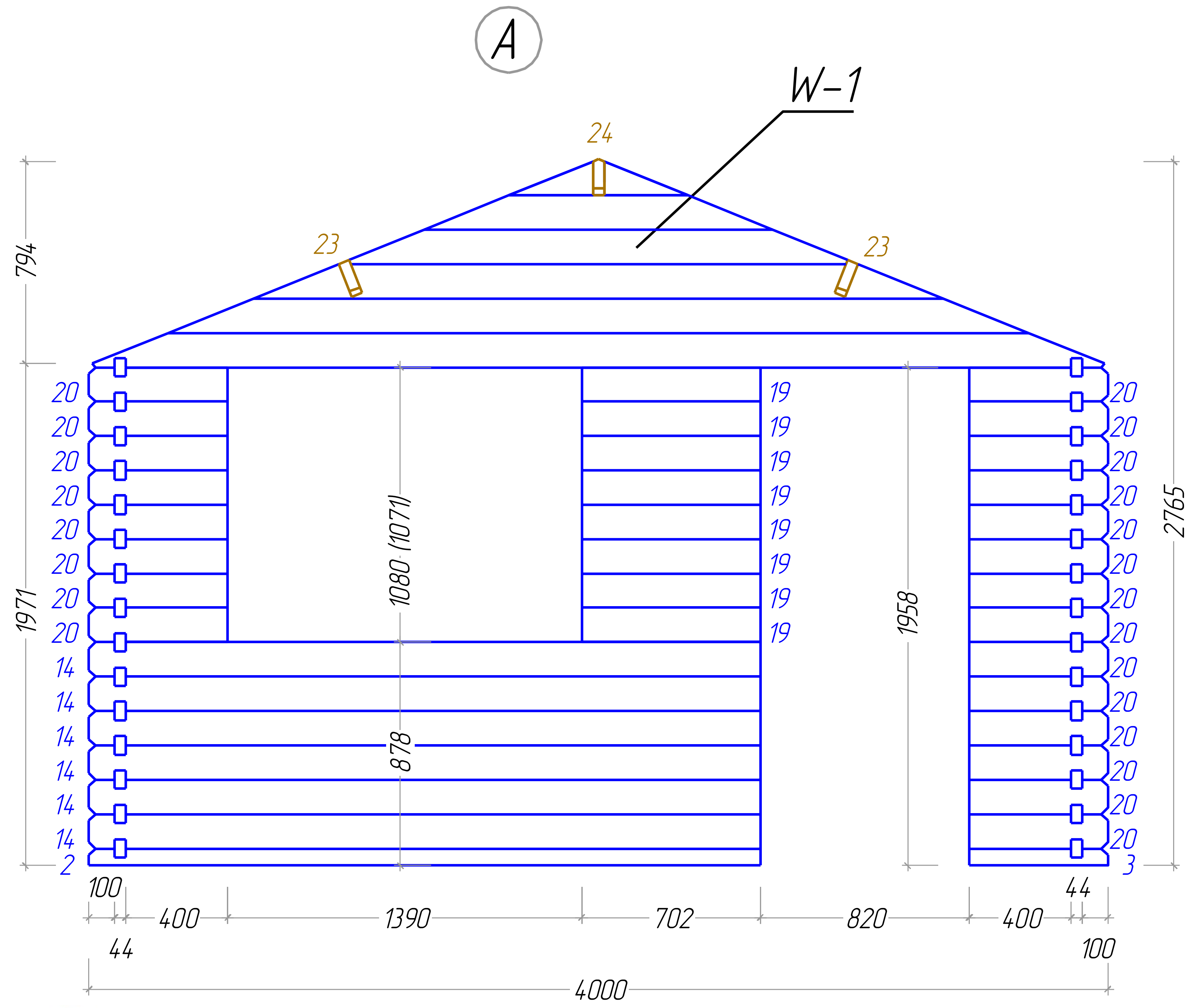

(C)

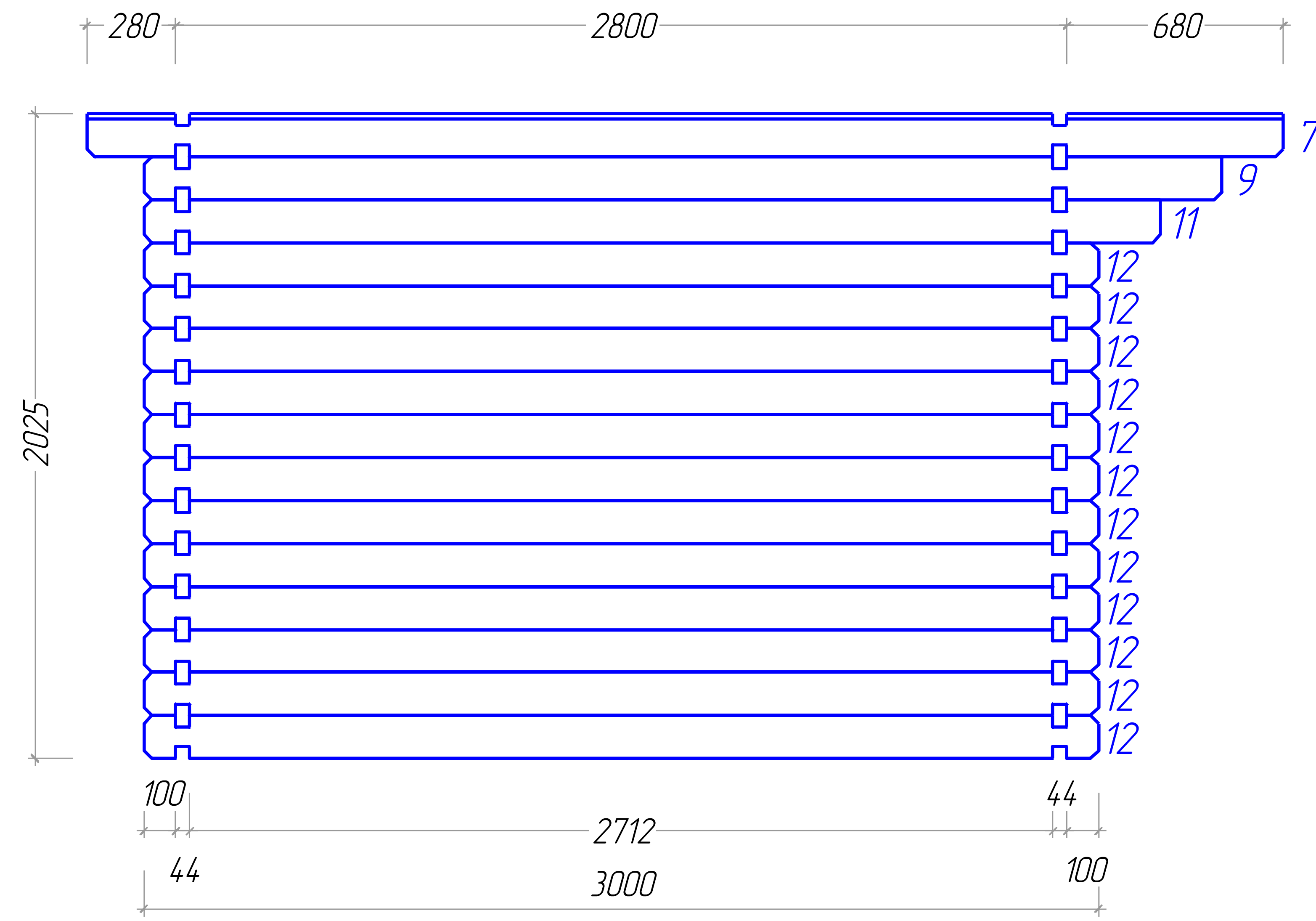

(D)

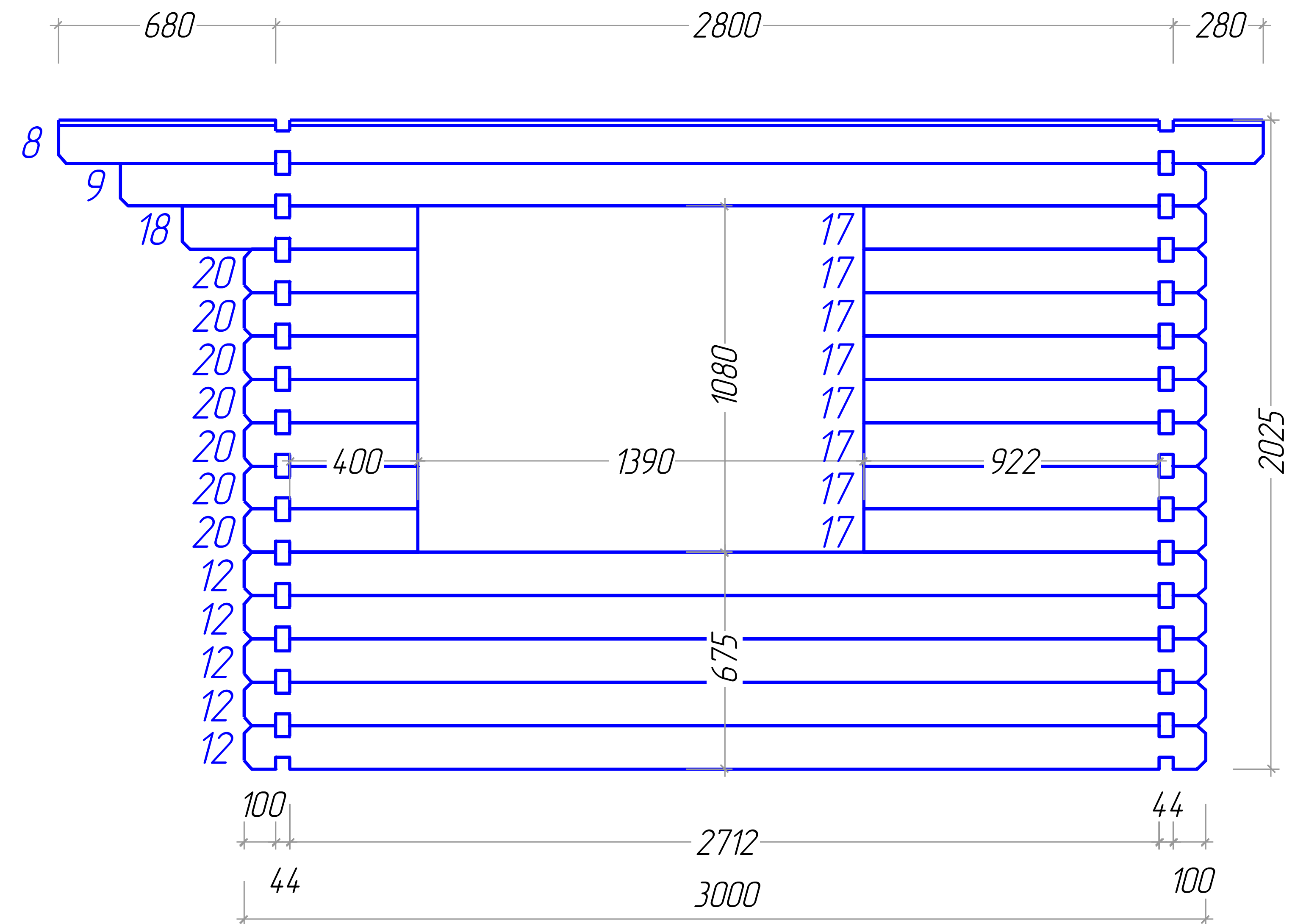

Dreux 4x3

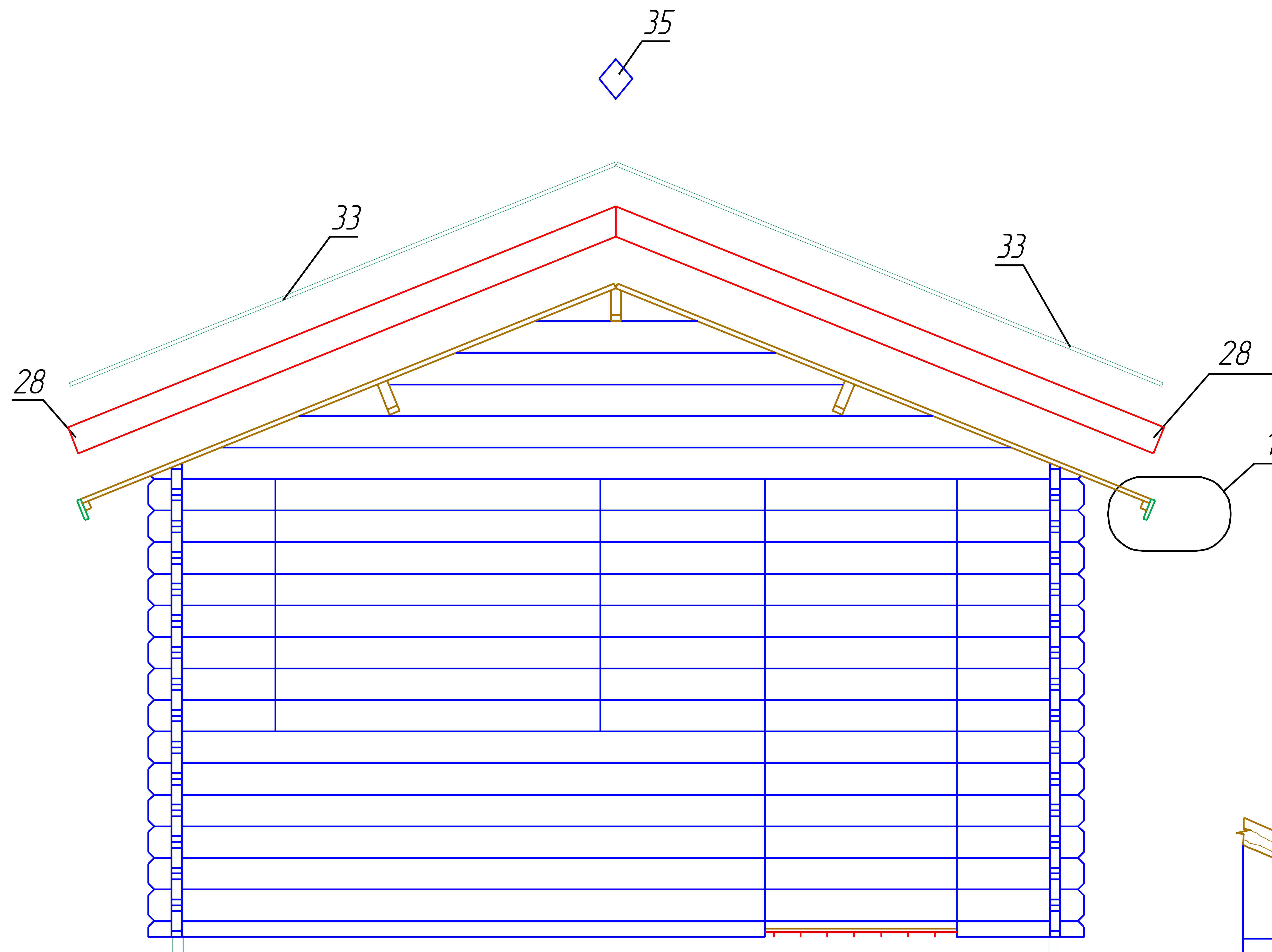

$\frac{1}{M 1:5}$

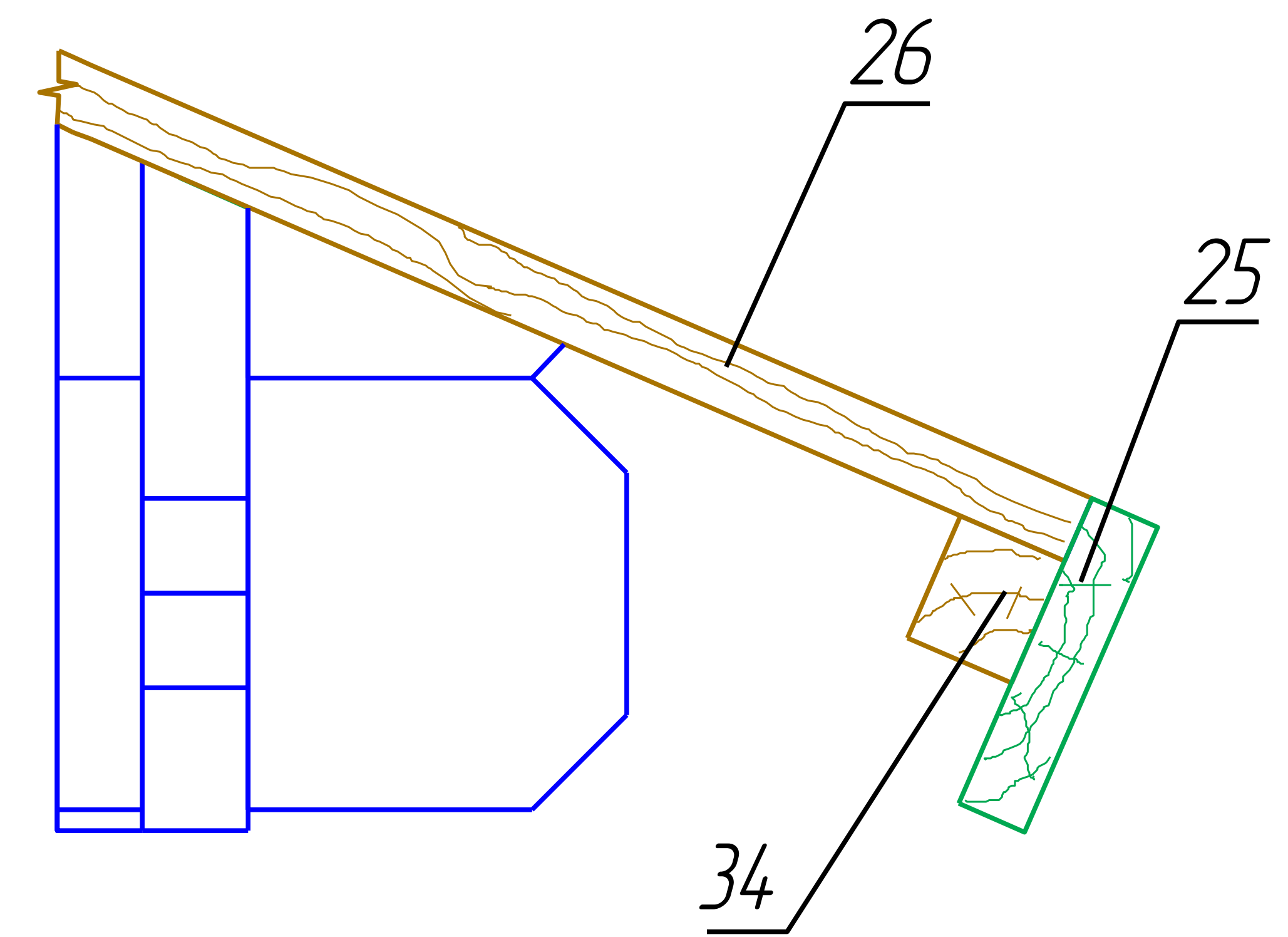

Dreux 4x3

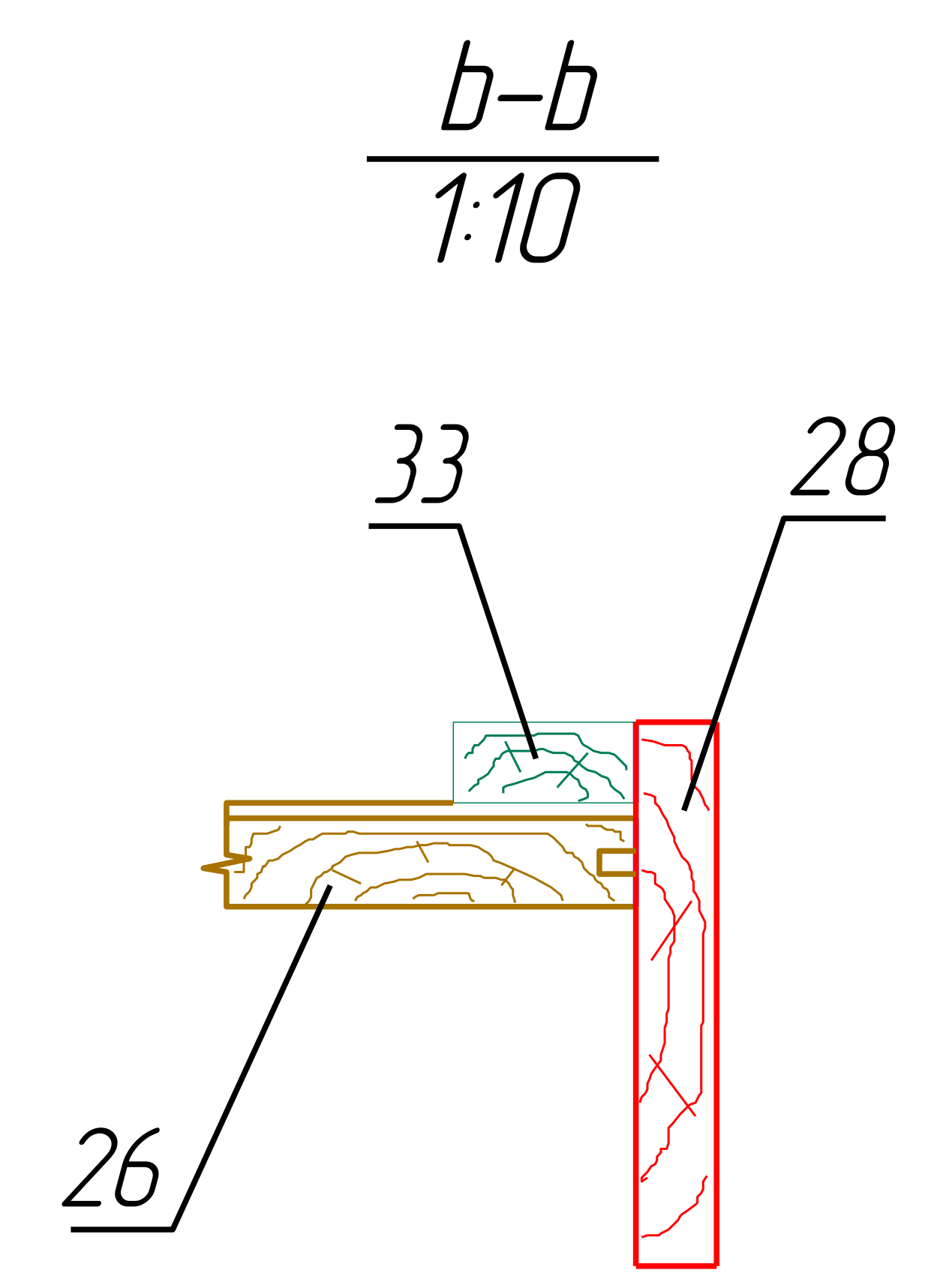
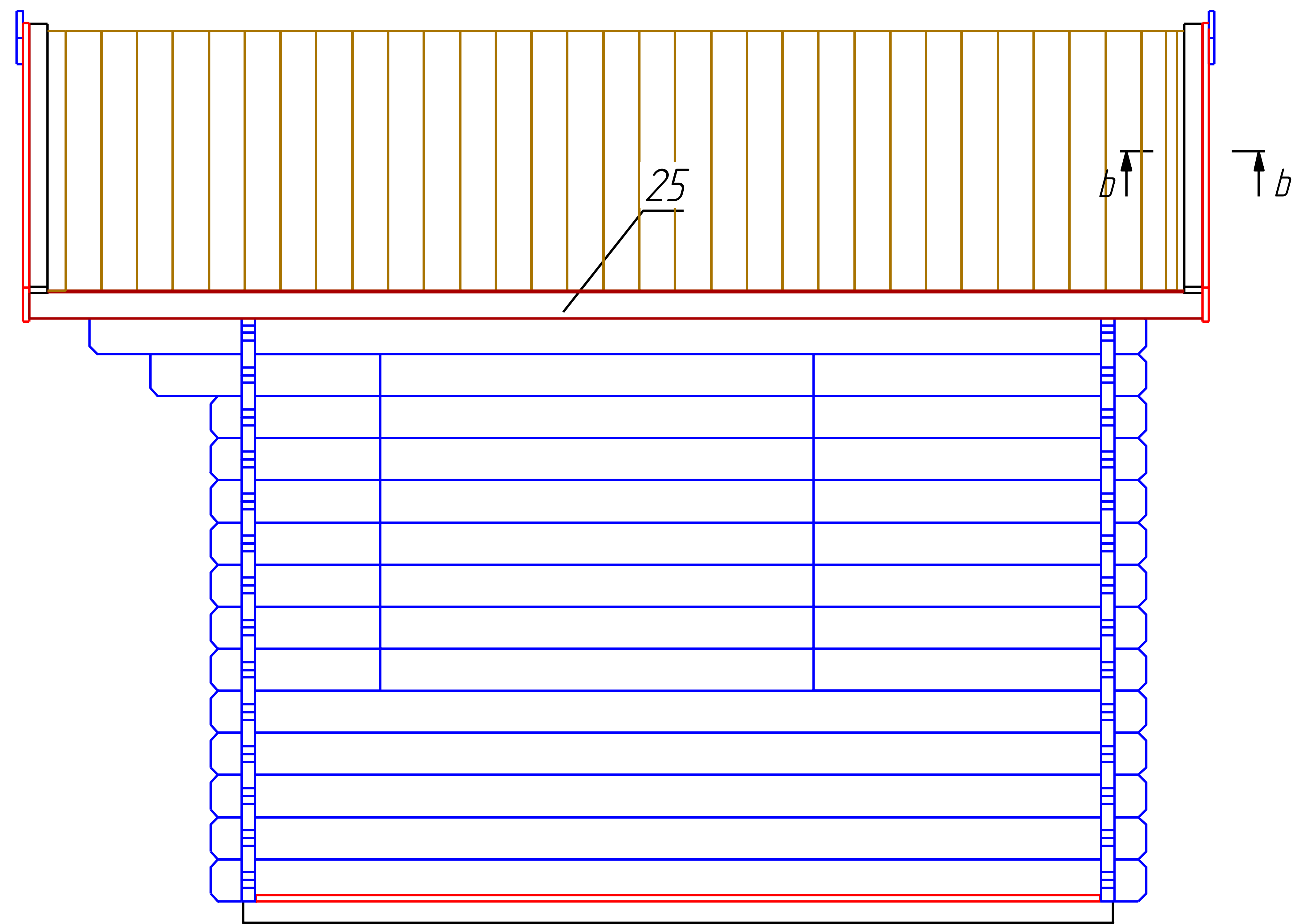

Dreux 4x3

Boarding joist plan

Trummplan

Lambourde plan







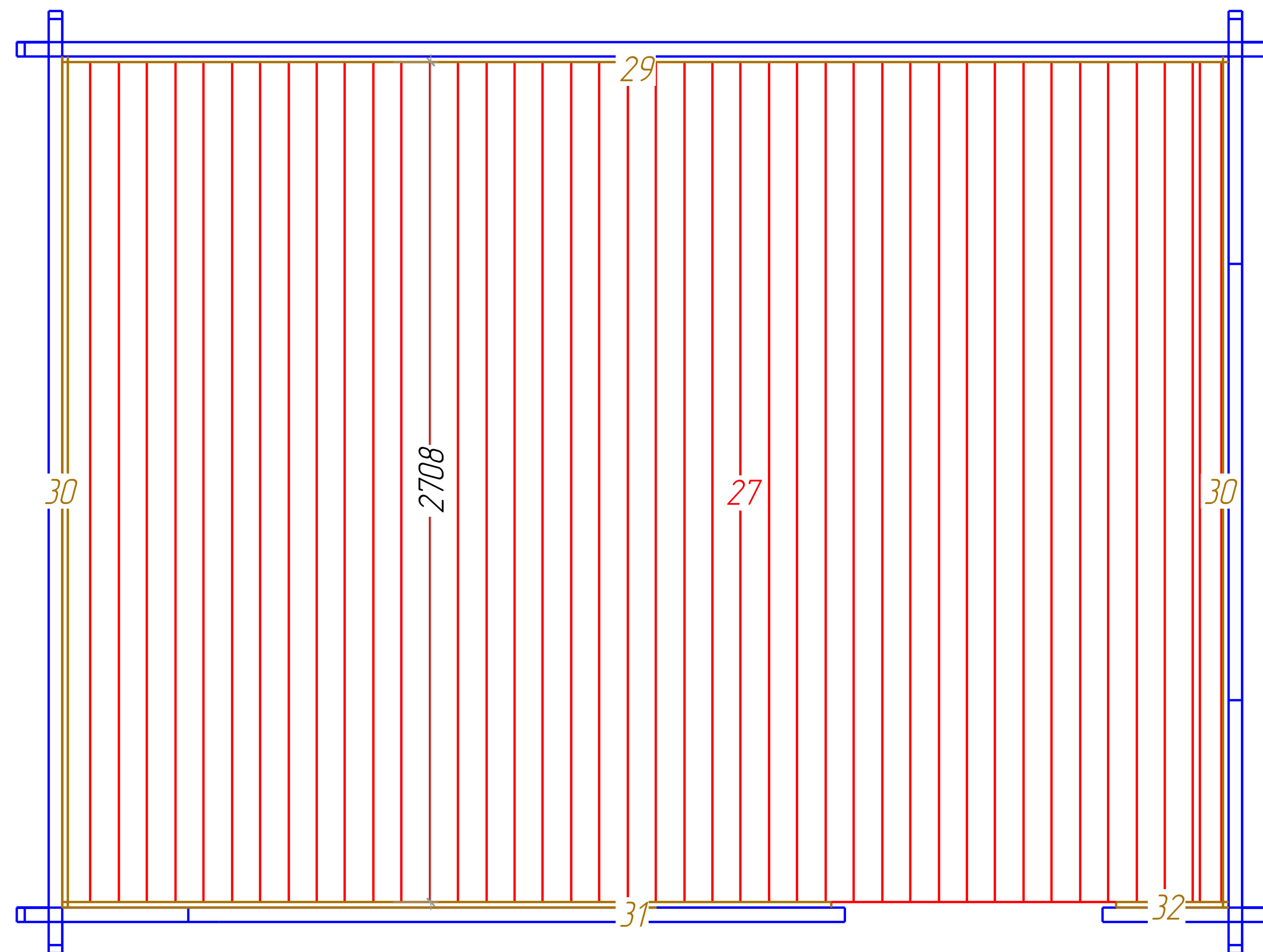

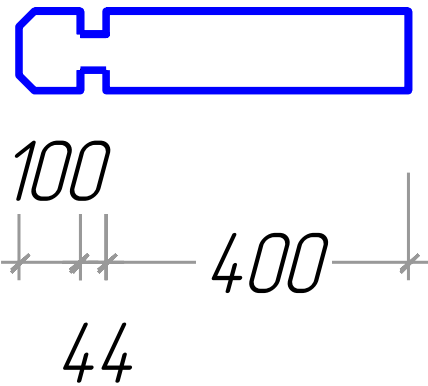

Dreux 4x3

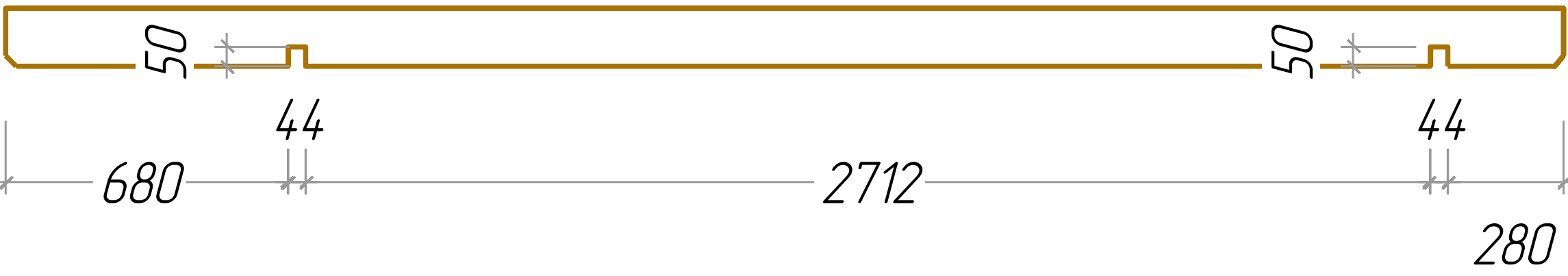
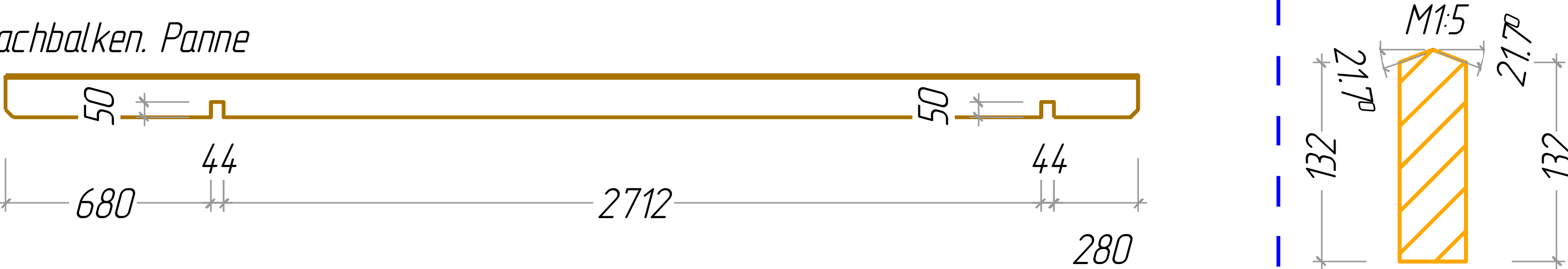
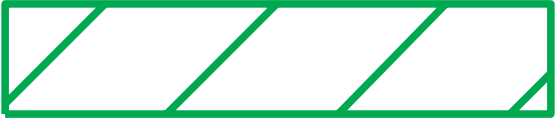
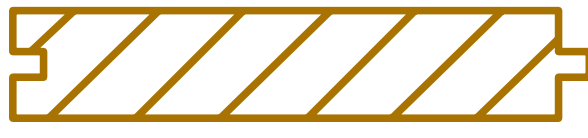
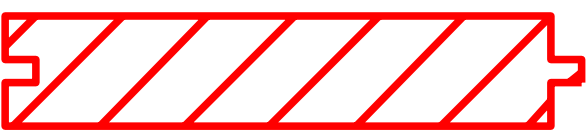
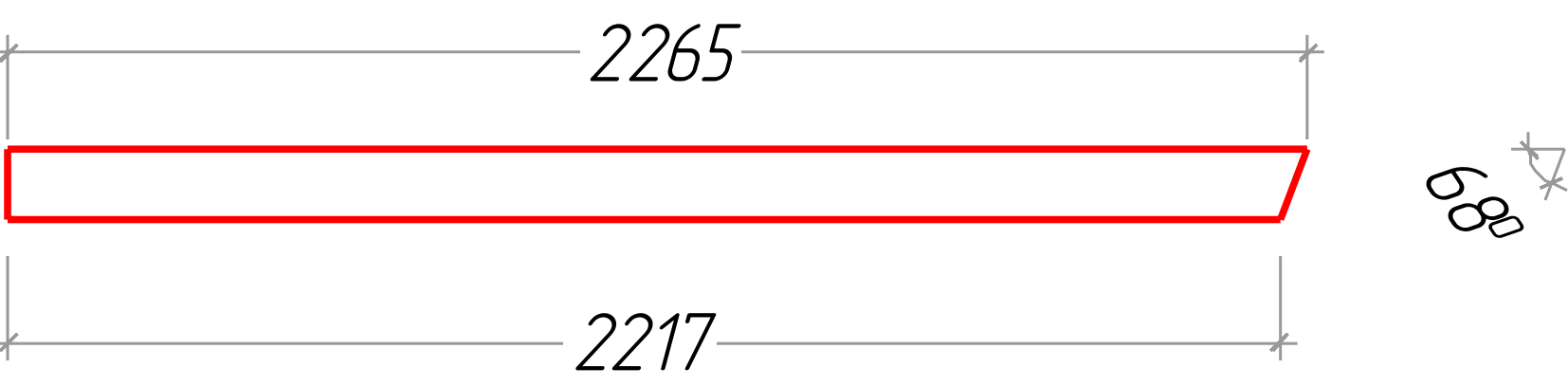
Plan of the floor board
Plan der Furbodenbretter
Le plan des plaches du plancher

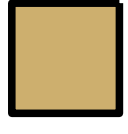

Nº	Dreux 4x3 M150	Nr.	Profile (mm)	Lenght (mm)
1		1	44x67,5	4000mm
2		1	44x67,5	2636mm
3		1	44x67,5	544mm
5		14+1	44x135	4000mm
7		1	44x135	3760mm
8		1	44x135	3760mm
9		2	44x135	3387mm
11		1	44x135	3193mm
12		17	44x135	3000mm
14		6	44x135	2636mm
17		8	44x135	1066mm
18		1	44x135	737mm
19		8	44x135	702mm

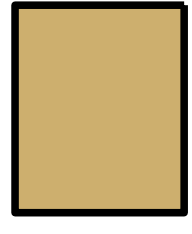
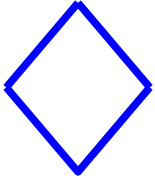
Nº	Dreux 4x3		M1:50	Nr.	Profile (mm)	Lenght (mm)
20				29	44x135	544mm
21	Foundation Fundament Solive			8	44x68	3702mm
22	Foundation Fundament Solive			2	44x68	2790mm
23	Roof beam. Dachbalken. Panne			2	44x140	3760mm
24	Roof beam. Dachbalken. Panne			1	44x140	3760mm
25	Roof side boards Traufenbrett Planche de rive		M1:10	2	18x90	3760mm
26	Roof boards. Dachbretter Volige		M1:5	66+1	20x115	2227mm
27	Floor boards Fu ssboden Lame de plancher		M1:5	33+1	20x115	2708mm
28	Fascia board Giebelblende Planch de rive facade			4	20x120	2265mm
29	Floor edge trim Fu bleisten Plinthe plancher		M1:5	1	20x18	3712mm
30	Floor edge trim Fu bleisten Plinthe plancher		M1:5	2	20x18	2712mm
31	Floor edge trim Fu bleisten Plinthe plancher		M1:5	1	20x18	2449mm
32	Floor edge trim Fu bleisten Plinthe plancher		M1:5	1	20x18	357mm

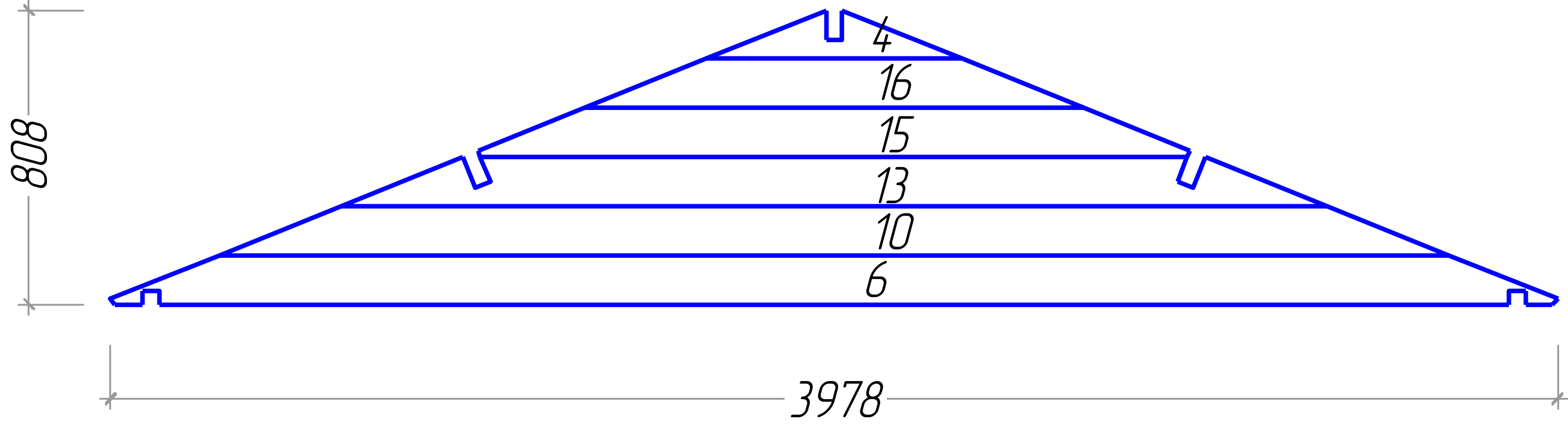
N°	Dreux 4x3 M150	Nr.	Profile (mm)	Lenght (mm)
33	<i>Roofing felt fillet</i> <i>Giebelabschlussbrett</i> <i>Latte de finition couverture</i> 	4	20x58	2256mm
34	<i>Roof edge reinforcement</i> <i>Traufenleiste</i> <i>Tasseau</i> 	2	28x34	3760mm
35	<i>Diamond</i> <i>Raute</i> <i>Diamant</i> 	2	T. 20	120mm
36	<i>Storm protection</i> 	4	28x34	1900mm
W-1		2		
	<i>Door</i> <i>Tur</i> <i>La porte</i> 1958x820 mm	1		
	<i>Window</i> <i>Fenetre</i> <i>Fenster</i> 1080x1390 mm	2		

Dreux 4x3

W-1
M 1:20

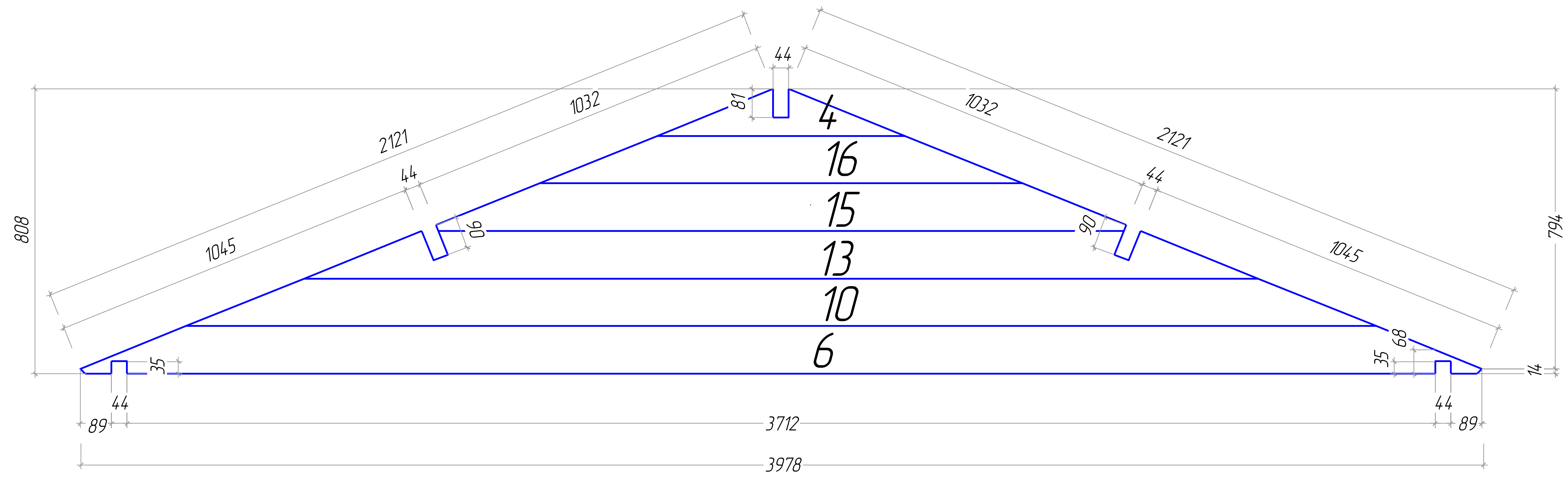

Storm protection

